

Product Category

※ Please click on series names for related introduction webpages or specifications.

Plastic Casing		Metal Casing	
	Non-PFC With Cable 8W ~ 35W APV/ APC Series 18W~150W LPV/ LPC Series IP67		Non-PFC With Terminal Block 200W/350W ERP Series PFC Terminal block 400W ERPF-400 Series
	PFC With Cable 25W~ 60W XLN Series IP67 NEW 16W~ 60W PCD / GSV Series 16W~ 200W LPF / NPF Series IP67 40W~ 200W PWM Series IP67		PFC With Cable 75W~300W ELG/ ELGC Series IP67 20/ 25/ 50/ 75/ 100/ 150/ 200/ 240/ 320W XLG / XLG-DA2 Series IP67
	PFC With Terminal Block 25W~60W XLC Series NEW 12W~80W PLM/ LCM/ LCM-40TW/ LDC Series Linear Series 50W/ 80W/ 150W SLD Series 75W/ 150W/ 240W SPWM Series NEW		PFC High Voltage Input 65~1000W HVG/ HVGC Series IP67
	PFC Open Frame Type 20W~ 240W PLP/ HLP/ HBG-P Series		PFC With Cable 40W~600W HLG/ HLG-C Series IP67
	DC/DC Module Type 9W~65W NHDD/ NLDD/ LDDS/ LDB/ LDH Series		PFC Circular Type 60W~300W HBG/ HBGC Series IP67 100/160/240W XBG Series IP67
	DALI-2 Intelligent Light System Controller/KNX Gateway NEW DLC-02/ DLC-02-KN Series Touch Panel NEW DTP Series PIR Motion Sensor DLS Series		

Roadmap

Matter/ PFC & Plastic Case/ Terminal Block

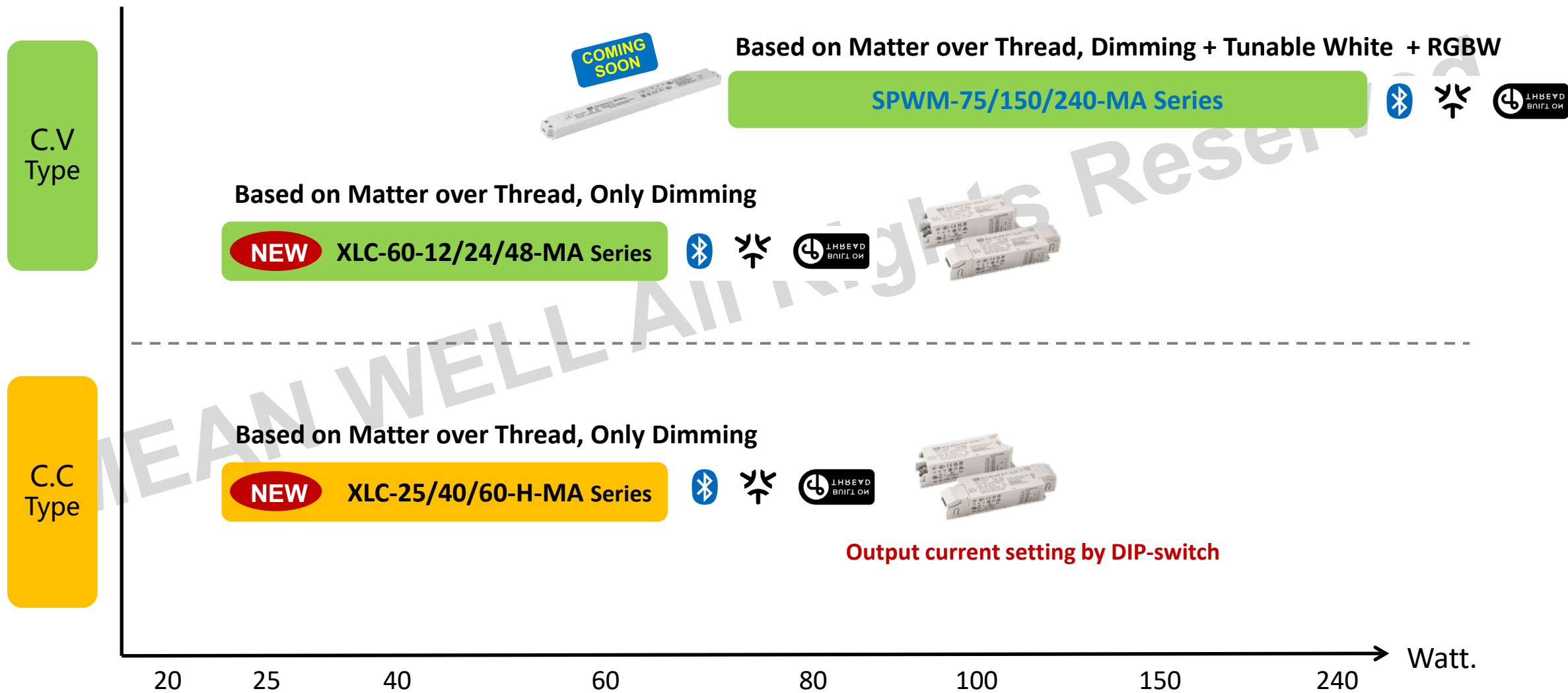

Roadmap

Non-PFC & Plastic Case — Lead Wire Type

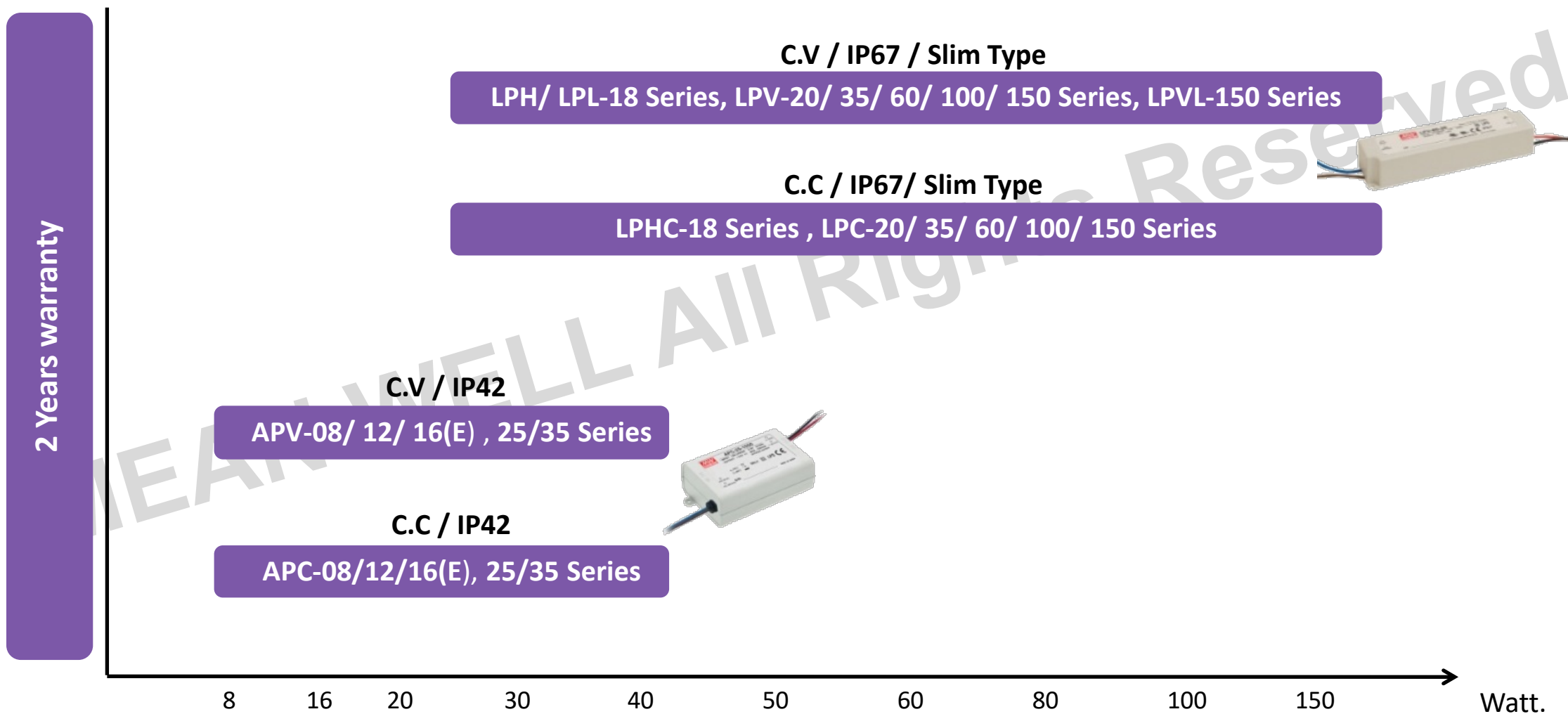

Roadmap

PFC & Plastic Case — Cable Type

※ Red words are new products

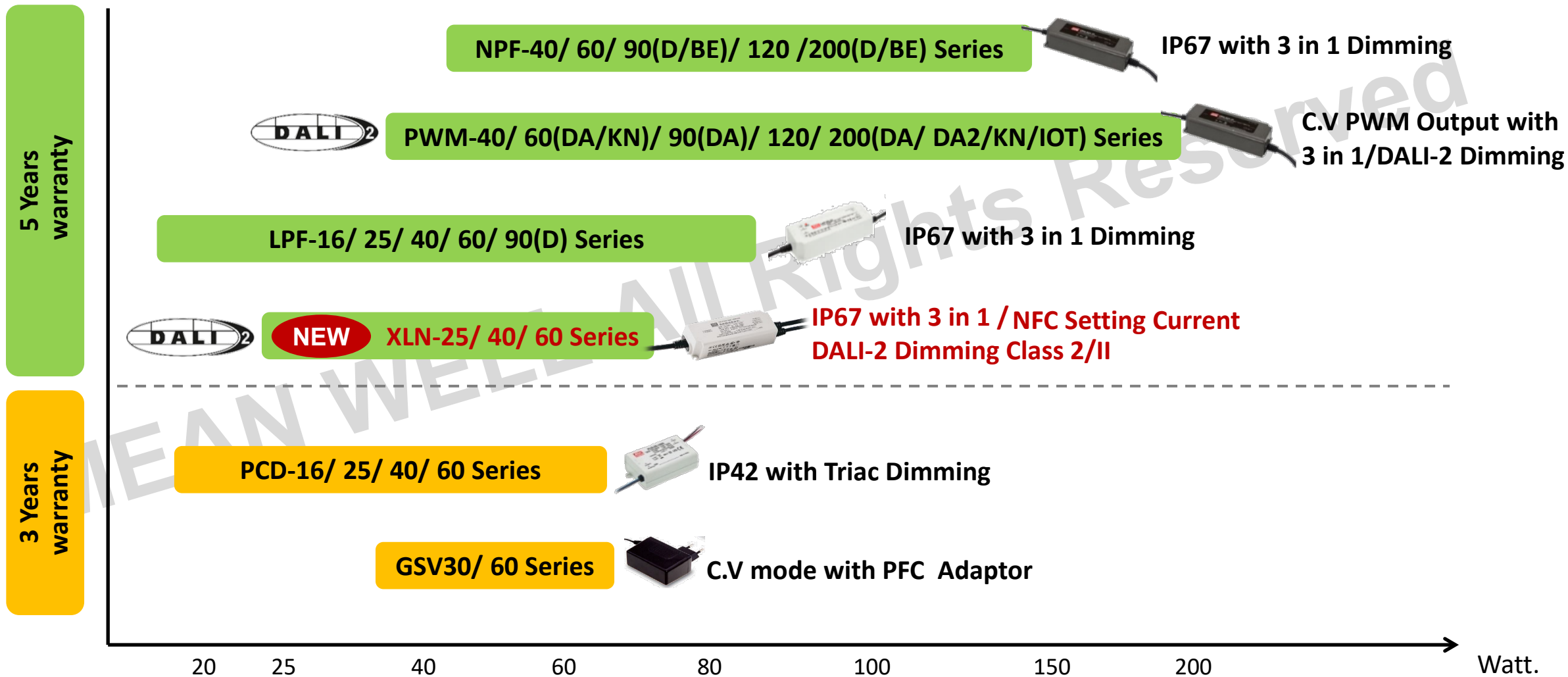

Roadmap

PFC & Plastic Case — Terminal Block

※ Red words are new products

5 Years warranty

3 Years warranty

2 Years warranty

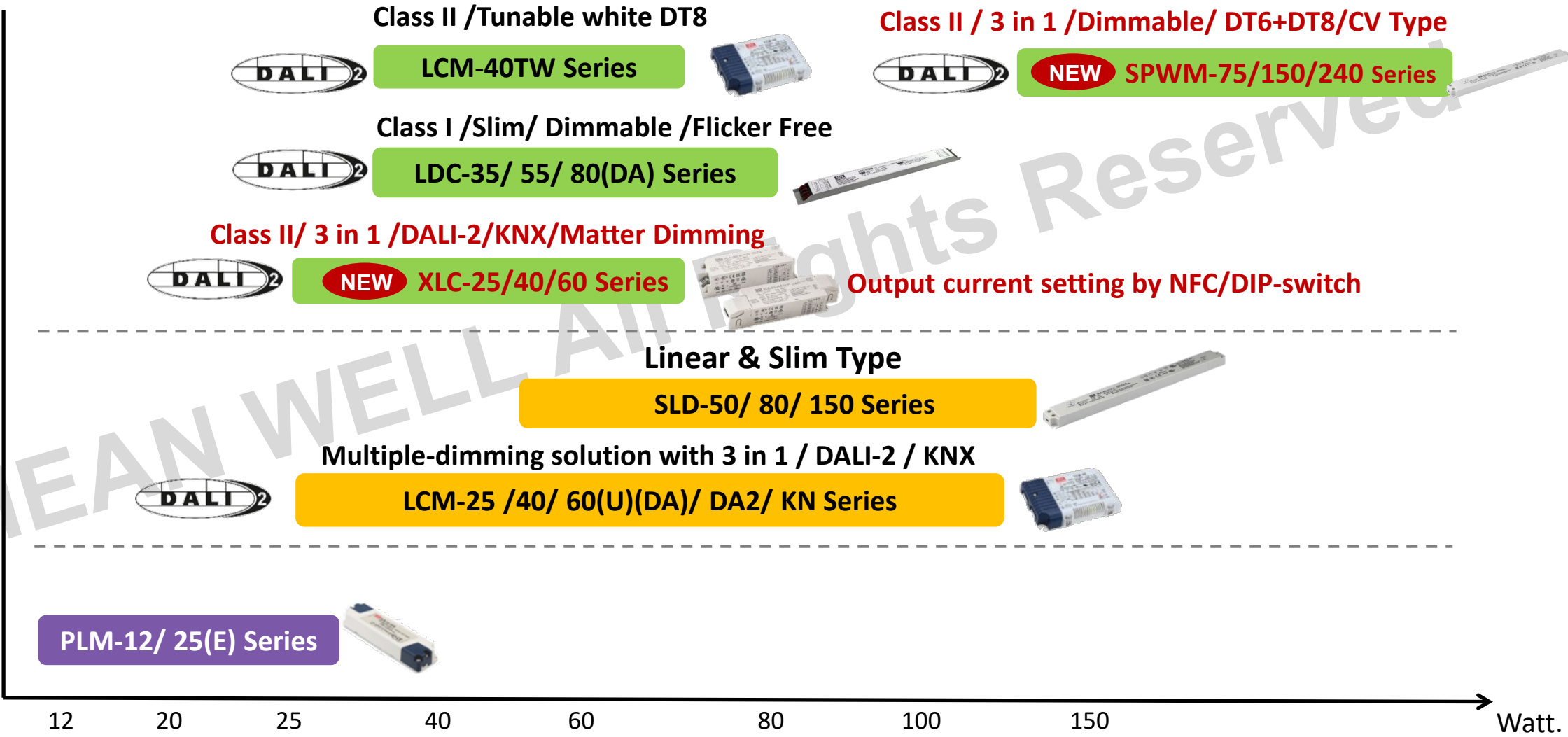

Roadmap PFC & Open Frame

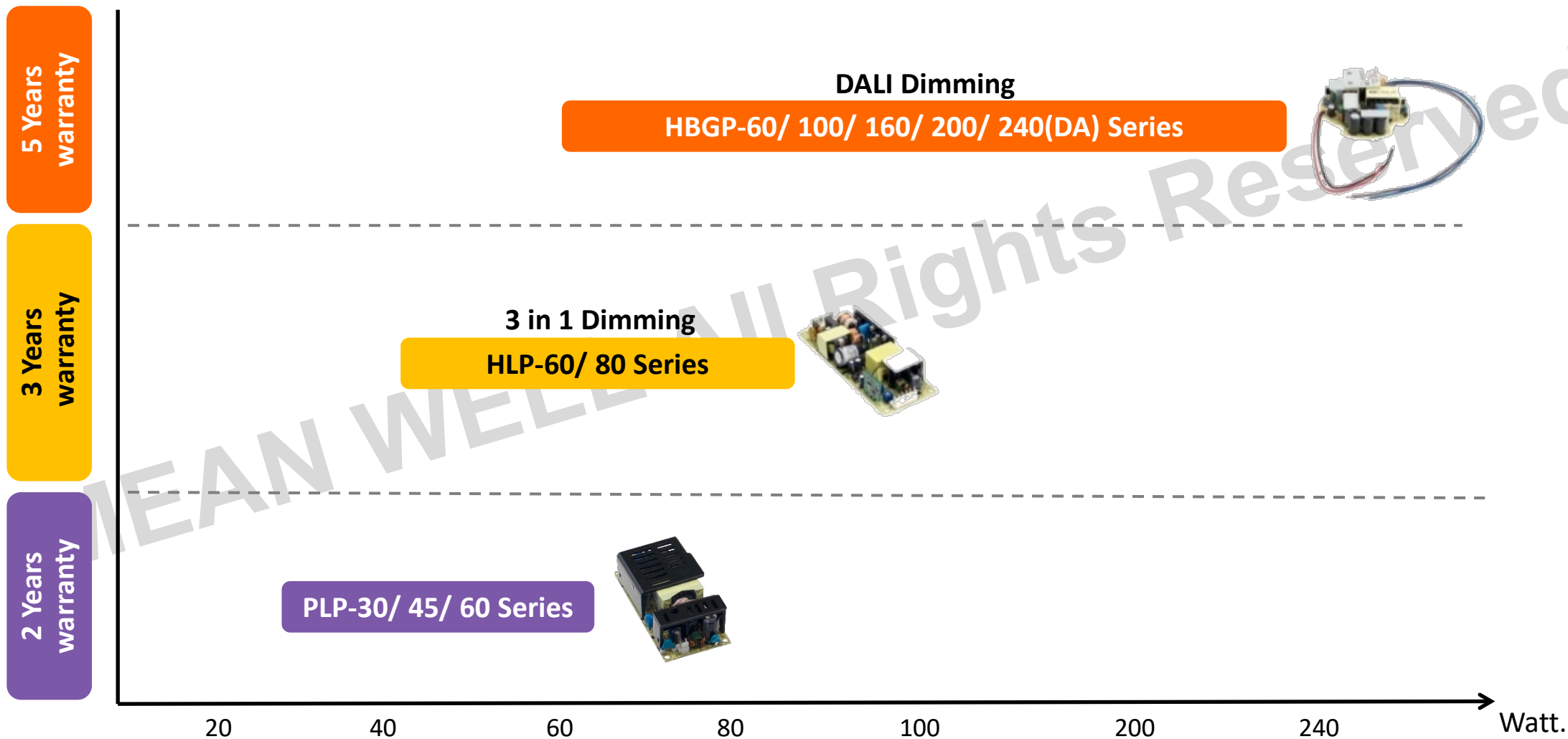

Roadmap

DC/DC C.C Mode Module

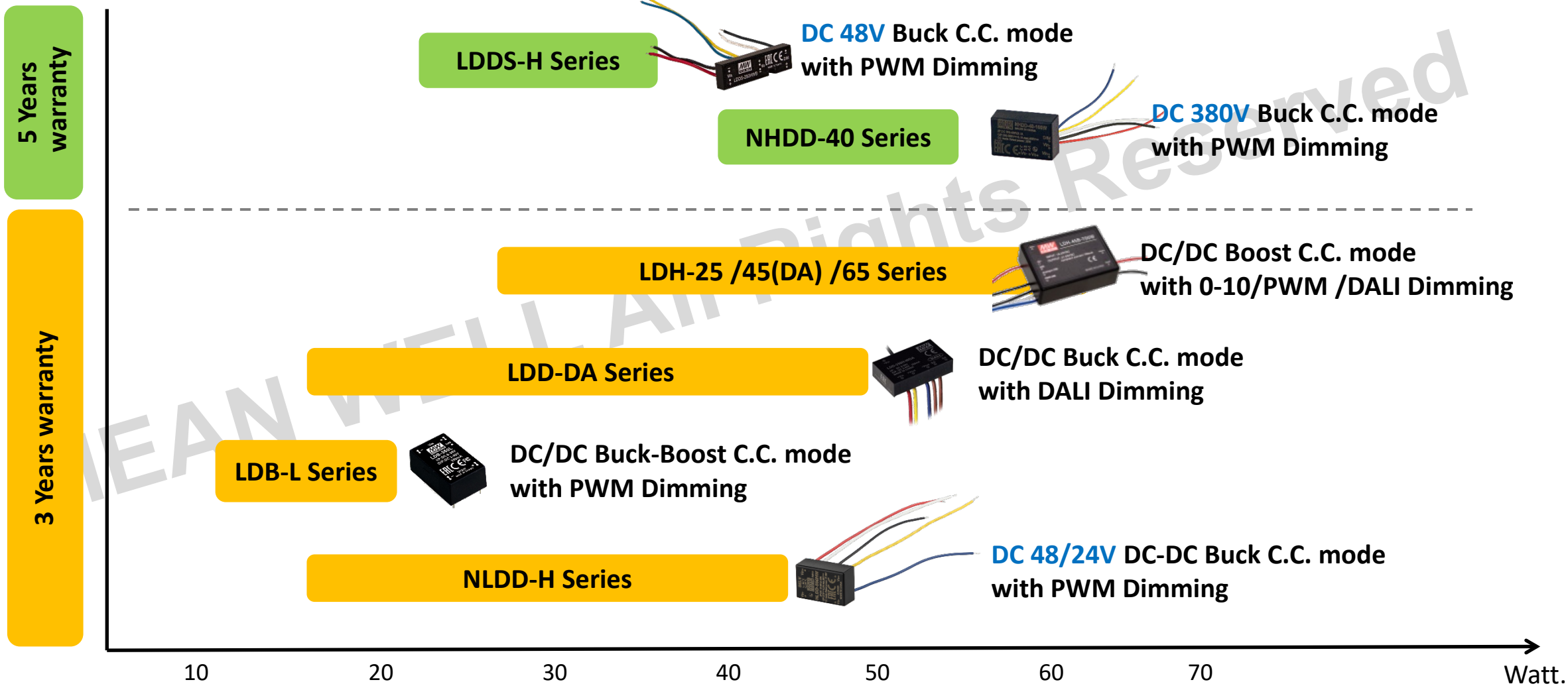

Roadmap

PFC & Metal Case — Cable Type

7 Years warranty

3 in 1 Dimming / C.V. or C.C. / IP67
HLG-40/ 60/ 100/ 120/ 150/ 185/ 240/ 320/ 480/ 600(-C) Series



5 Years warranty

3 in 1 dimming / DALI-2 dimming /C.P./IP67
XLG-20/ 25/ 50/ 75/ 100/ 150/ 200/ 240/ 320 Series



3 in 1 /DALI / Timer Dimming / C.V. or C.C. / IP67
ELG(C)-75/ 100/ 150/ 200/ 240/ 300 (DA) Series



3 in 1 Dimming / C.V. or C.C./IP67
HVG(C)-65/ 100/ 150/ 240/ 320/ 480(DA)/ 650(DA)/ 1000(DA2) Series

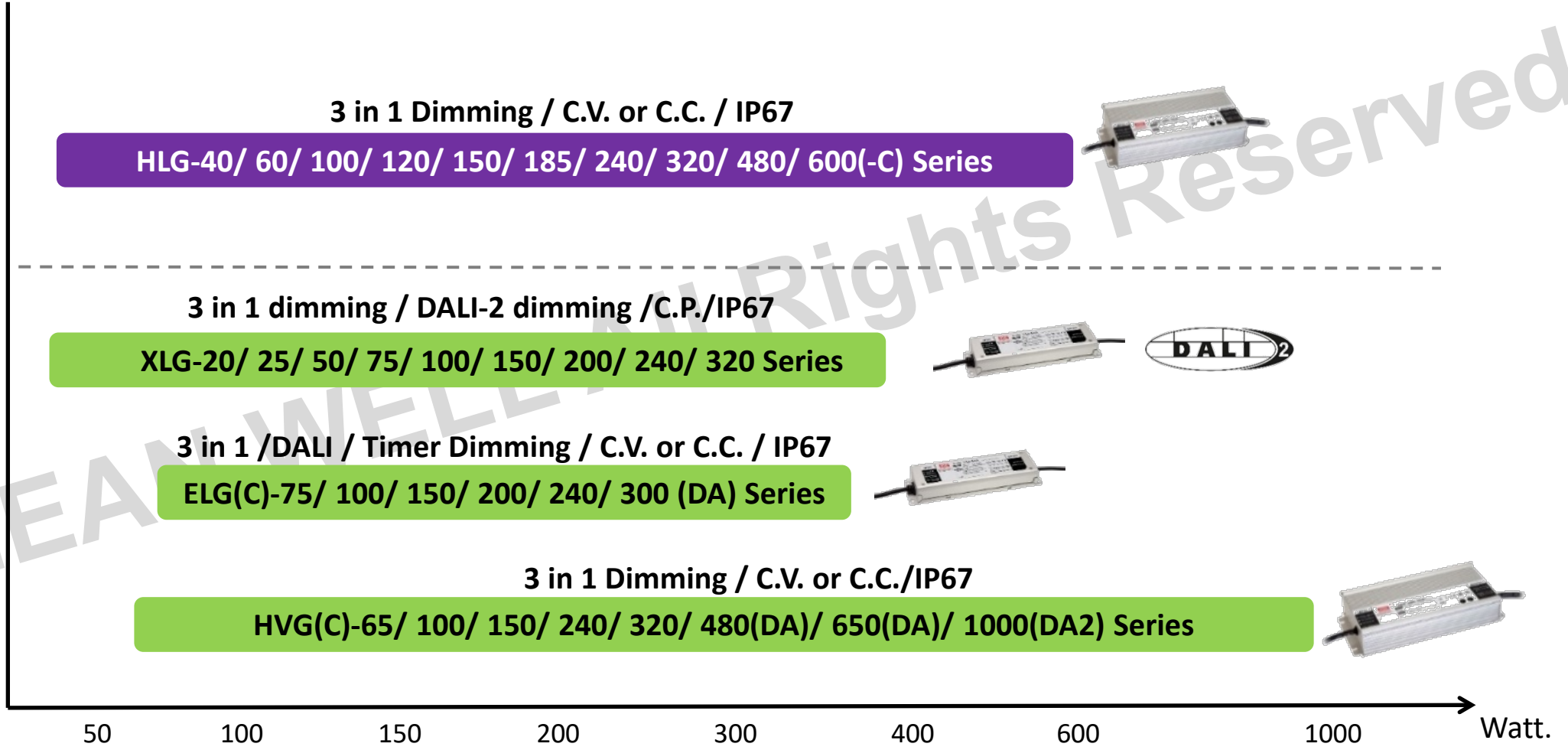

Roadmap PFC & Circular Case

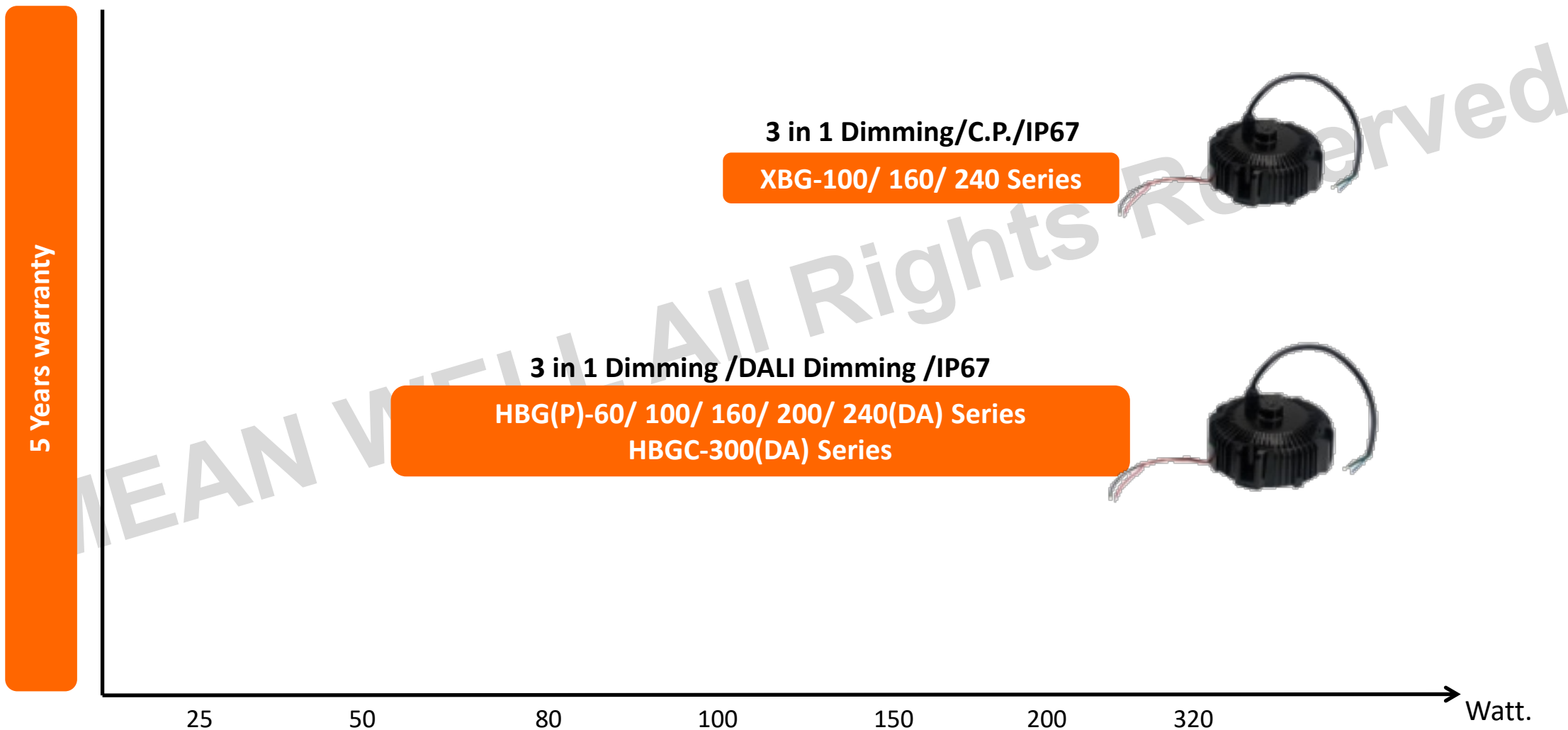

Roadmap

DALI-2 Digital Lighting Controller

5 Years warranty



DALI-2 Controller



KNX Gateway

DLC-02/ DLC-02-KN Series

Digital Lighting & Building Automation All-in-One Digital Lighting System



Roadmap

DALI-2 Touch Panel

※ Red words are new products

5 Years warranty



DTP-203/206-E
(3 keys/6 keys)



DTP-204/206-U
(4 keys/6 keys)

NEW **DTP-2xx Series** **DALI-2 Touch Panel**



Compliant With IEC62386-101 / 103 / 301 / 332 Standards

Road Map

DALI-2 PIR Motion Sensor

※ Red words are new products

5 Years warranty



DLS-203-P
(Low-mounting)
Flush mounting



DLS-208-P
(High-mounting)
Flush mounting/surface mounting available

NEW **DLS-2xx Series DALI-2 PIR Motion Sensor**
(Daylight sensor detection available)



Compliant With IEC62386-101 / 103 / 303 / 304 Standards

DALI-2 Digital Lighting System



For more information >
DALI Digital Lighting System Solutions

DALI 2
 DLC-02
 DALI-2 Digital Lighting Controller

AC mains

DALI Bus



NEW

DTP-2xx series
 DALI-2
 Touch Panel
 U Version



NEW

DTP-2xx series
 DALI-2
 Touch Panel
 E Version



NEW

DALI-2 PIR Motion Sensor
 (Low-mounting)



NEW

DALI-2 PIR Motion Sensor
 (High-mounting)



NEW

SPWM series
 DALI-2 **DT6/DT8**
 C.V mode
 Dimmable
 C.W. + RGBW



XLN/XLC series
 PWM series
 DALI-2 **DT6**
 C.V mode



LCM series
 DALI-2 **DT8**
 C.C mode
 Tunable White



XLN/XLC series
LCM series
 DALI-2 **DT6**
 C.C mode